

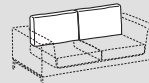

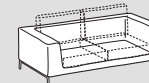





 Seduta - Seat	 Schienali - Backrests	 Struttura - Structure	
Rivestimento Upholstering (10)	Sfoderabile Removable  	Sfoderabile Removable  	Sfoderabile Removable 	
	Non sfoderabile Not removable -	Non sfoderabile Not removable -	Non sfoderabile Not removable 	
Imbottiture Padding (3-4-5-6-7-8-9)	 D.35/40kg/m³	 D.21kg/m³	 Tecnoform	 Optional

INFORMAZIONI TECNICHE

Struttura: 1

Struttura base in pannelli di legno multistrati in classe E1 con barre di rinforzo in metallo. Masselli portanti in legno di abete. Elementi strutturali in pannelli di legno multistrati in classe E1 e tamponamenti in faesite.

Molleggio: 1-2

Schienale in pannello di faesite.

Seduta in nastri elastici di fibra propilenica e lattice incrociati e meccanicamente pretensionati.

TECHNICAL INFORMATION

Structure: 1

Frame structure in plywood panels in class E1 with metal reinforcement bars. Solid bearing fir wood. Structural elements in plywood panels in class E1 and infill in faesite.

Springing: 1-2

The back is made of hardboard panels.

Seat with pre-tensioned crossed propylene fibre and latex elastic webbing.

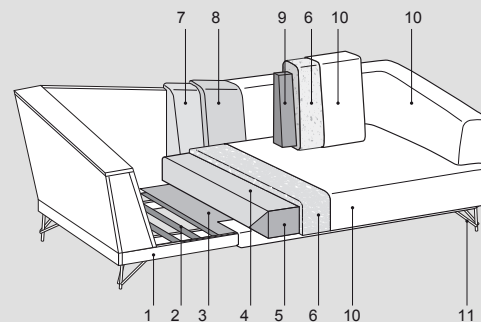
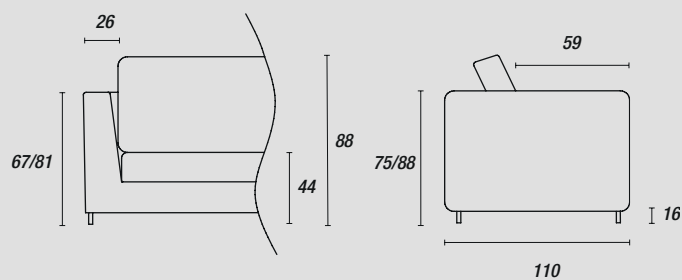

Piedini - Feet:

di serie Lennox



H.16cm

Nero (ME09)

optional Sled











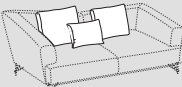
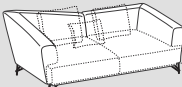

H.16cm

con maggiorazione Nero (ME09)

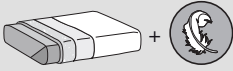
Lennox soft

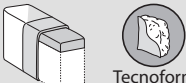

	 Seduta - Seat	 Set cuscini - Cushions set	 Struttura - Structure	
Rivestimento Upholstering (10)	Sfoderabile Removable  			
	Non sfoderabile Not removable -	-		
Imbottiture Padding (3-4-5-6-7-8-9)	 D.35/40kg/m³	 Misto piuma	 Tecnoform	 Optional

INFORMAZIONI TECNICHE

Struttura: 1

Struttura base in pannelli di legno multistrati in classe E1 con barre di rinforzo in metallo. Masselli portanti in legno di abete. Elementi strutturali in pannelli di legno multistrati in classe E1 e tamponamenti in faesite.

Molleggio: 1-2

Schienale in pannello di faesite.

Seduta in nastri elastici di fibra propilenica e lattice incrociati e meccanicamente pretensionati.

TECHNICAL INFORMATION

Structure: 1

Frame structure in plywood panels in class E1 with metal reinforcement bars. Solid bearing fir wood. Structural elements in plywood panels in class E1 and infill in faesite.

Springing: 1-2

The back is made of hardboard panels.

Seat with pre-tensioned crossed propylene fibre and latex elastic webbing.

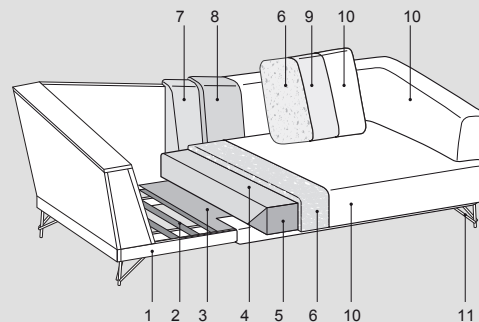
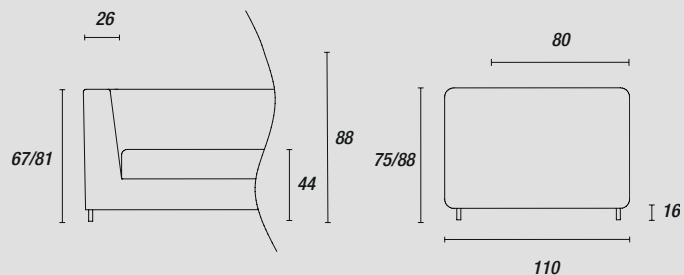

Piedini - Feet:

di serie Lennox



H.16cm
Nero (ME09)

optional Sled



H.16cm
con maggiorazione
Nero (ME09)