

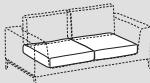

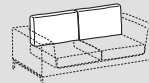

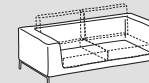









# Bijoux

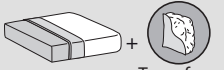

	 Seduta - Seat	 Schienali - Backrests	 Struttura - Structure	
<b>Rivestimento Upholstering (9)</b>	Sfoderabile Removable   	Sfoderabile Removable   	Sfoderabile Removable   	
	Non sfoderabile Not removable -	Non sfoderabile Not removable -	Non sfoderabile Not removable -	
<b>Imbottiture Padding (2-4-5-6-7)</b>	 Tecnoform D.35kg/m³	 Misto piuma	 Tecnoform	 Optional

## INFORMAZIONI TECNICHE

### Struttura: 1

Masselli portanti in legno di abete. Elementi strutturali in pannelli di legno multistrati in classe E1 e pannelli di particelle di legno in classe E1, tamponamenti in faesite.

### Molleggio: 1-3

Schienale in pannello di faesite.

Seduta in nastri elastici di fibra propilenica e lattice incrociati e meccanicamente pretensionati.

### Note:

Piedini di serie in legno con bordo metallizzato, opzionali piede ad effetto sospeso o, con maggiorazione, basamento in legno.

Libreria, piano o tavolino in acciaio verniciato.

## TECHNICAL INFORMATION

### Structure: 1

Solid bearing fir wood. Structural elements in multilayer wood panels in class E1 and panels of wood particles in class E1, infills in faesite.

### Springing: 1-3

The back is made of hardboard panels.

Seat with pre-tensioned crossed propylene fibre and latex elastic webbing.



### Note:

Wooden standard feet with metalized edge, hanging effect foot optional or, with a surcharge, wooden base.

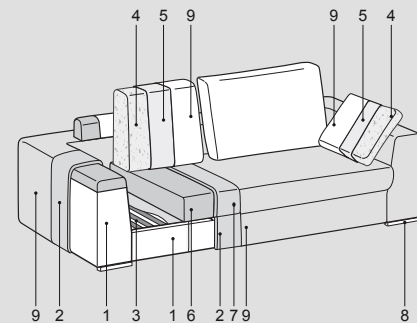
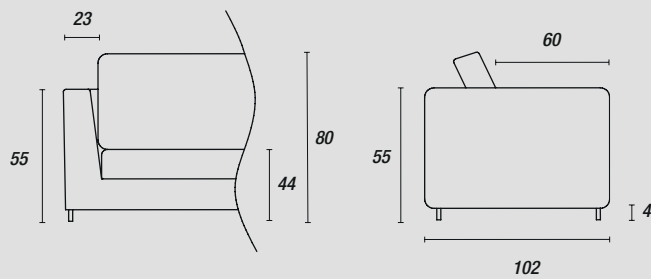

Laquered steel bookcase, top or small table.

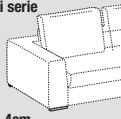

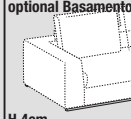
### Piedini - Feet:

 di serie H.4cm Nero opaco con bordo metallizzato	 effetto sospeso H.4cm Nero (ME09)	 optional Basamento H.4cm con maggiorazione nero opaco
---	--	---

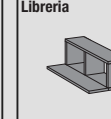
### Accessori - Accessories:

 Piano Antracite (ME01) Testa di moro (ME03)	 Libreria Antracite (ME01) Testa di moro (ME03)	 Tavolino Antracite (ME01) Testa di moro (ME03) Peltro (ME13)
--	---	--

# Bijoux next



	Seduta - Seat	Schienali - Backrests	Struttura - Structure	
<b>Rivestimento Upholstering (9)</b>	Sfoderabile Removable 	Sfoderabile Removable 	Sfoderabile Removable 	
	Non sfoderabile Not removable	Non sfoderabile Not removable	Non sfoderabile Not removable	
<b>Imbottiture Padding (2-4-5-6-7)</b>	 D.35kg/m³	 Misto piuma	 Tecnoform	 Optional

## INFORMAZIONI TECNICHE

### Struttura: 1

Masselli portanti in legno di abete. Elementi strutturali in pannelli di legno multistrati in classe E1 e pannelli di particelle di legno in classe E1, tamponamenti in faesite.

### Molleggio: 1-3

Schienale in pannello di faesite. Seduta in nastri elastici di fibra propilenica e lattice incrociati e meccanicamente pretensionati.

### Note:

Piedini di serie in legno con bordo metallizzato, opzionali piede ad effetto sospeso o, con maggiorazione, basamento in legno. Libreria, piano o tavolino in acciaio verniciato.

## TECHNICAL INFORMATION

### Structure: 1

Solid bearing fir wood. Structural elements in multilayer wood panels in class E1 and panels of wood particles in class E1, infills in faesite.

### Springing: 1-3

The back is made of hardboard panels. Seat with pre-tensioned crossed propylene fibre and latex elastic webbing.

### Note:

Wooden standard feet with metalized edge, hanging effect foot optional or, with a surcharge, wooden base. Laquered steel bookcase, top or small table.

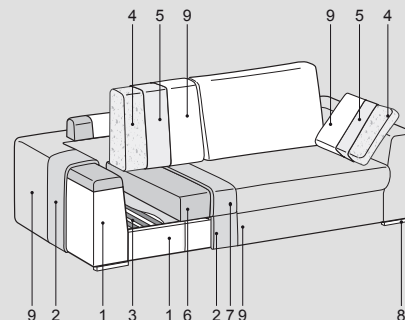
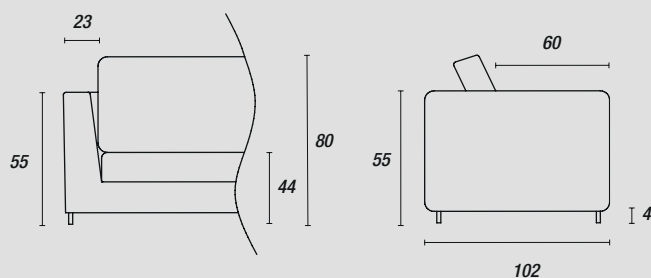

### Piedini - Feet:

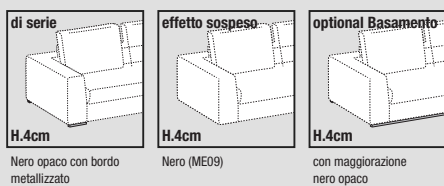

### Accessori - Accessories:

