

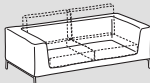

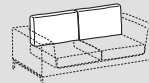



Crossline

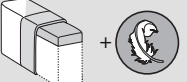

	 Struttura - Structure	 Schienali - Backrests	
Rivestimento Upholstering (8)	Sfoderabile Removable 		
	Non sfoderabile Not removable 	-	
Imbottiture Padding (3-4-5-6-7)	 D.35kg/m³	 25kg/m³	 Optional

INFORMAZIONI TECNICHE

Struttura: 1

Masselli portanti in legno di abete. Elementi strutturali in pannelli particelle di legno in classe E1, tamponamenti in faesite.

Molleggio: 1-2

Schienale in pannello di faesite. Seduta in nastri elastici di fibra propilenica e lattice incrociati e meccanicamente pretensionati.

Note:

Tavolini in pannelli di particelle di legno in classe E1.

TECHNICAL INFORMATION

Structure: 1

Solid fir wood. Structural elements in particle wood panels in class E1, infill in faesite.

Springing: 1-2

The back is made of hardboard panels. Seat with pre-tensioned crossed propylene fibre and latex elastic webbing.

Note:

E1 particleboard panels veneered wooden small tables.

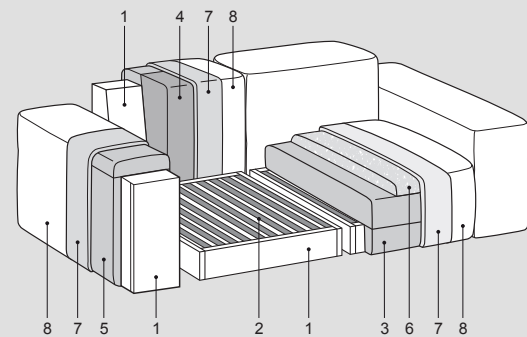
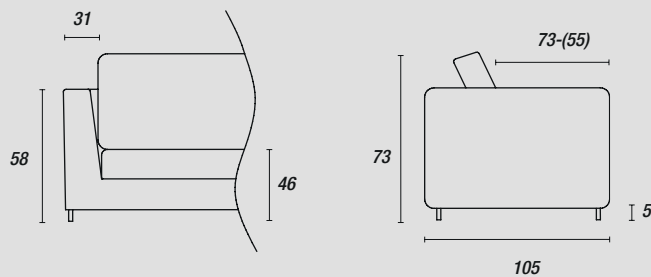

Piedini - Feet:

di serie



H.5cm

nero opaco

optional Basamento

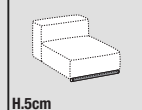

H.5cm

Light brown (ME11)
con puntale inox

nero opaco
con puntale nero lucido

Accessori - Accessories:

Tavolini

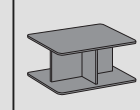

Antracite (LE01)
Grigio Seta (LE10)
Ambra (LE21)