

Franz

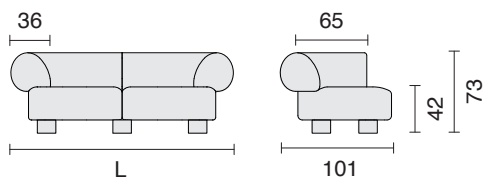

Caratteristiche del prodotto

Su misura: non disponibile.

Struttura portante: multistrato e pannelli in faesite.

Struttura di molleggio: cinghie elastiche incrociate.

Imbottitura schienale: poliuretano espanso.

Imbottitura seduta: poliuretano espanso a densità differenziata.

Piedini: acciaio laccato H. 12 cm a vista.

Colori piedini: tutte le finiture.

Modularità

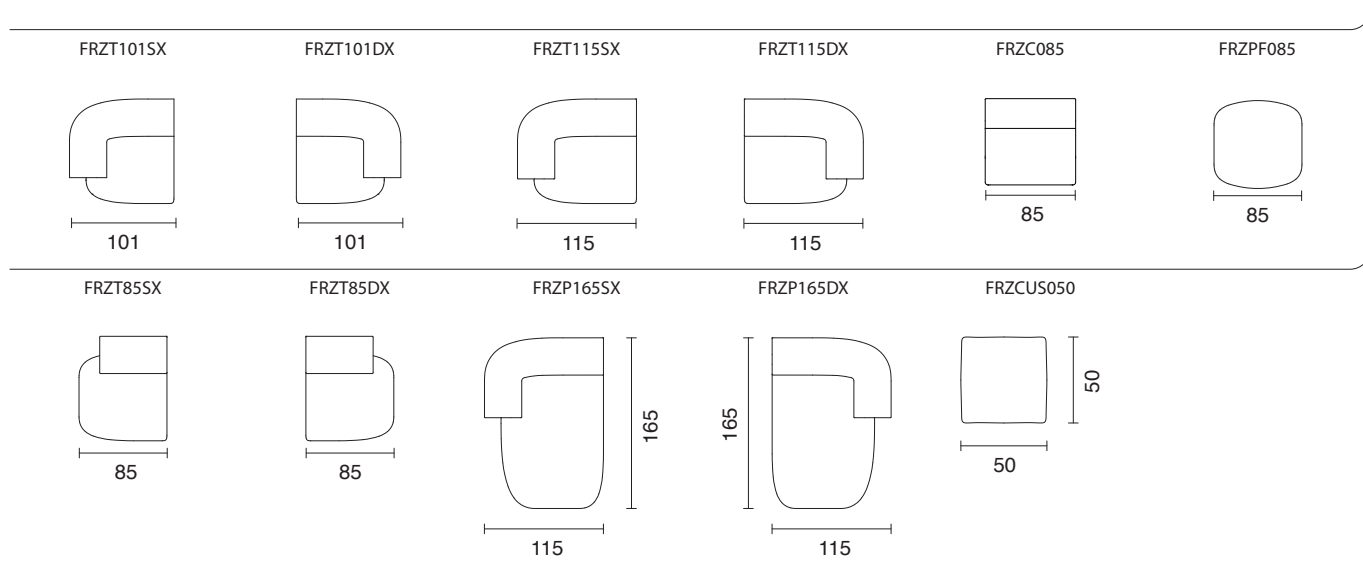

Franz

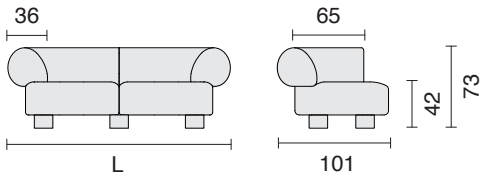

Characteristics of the product

Tailor-made: not available.

Supporting structure: plywood and hardboard panels.

Springing system: crossed elastic straps.

Filler for backrest: polyurethane foam.

Filler for seat: polyurethane foam with variable density.

Feet: lacquered metal h. 12 cm.

Colour of feet: in all finishes.

Modularity

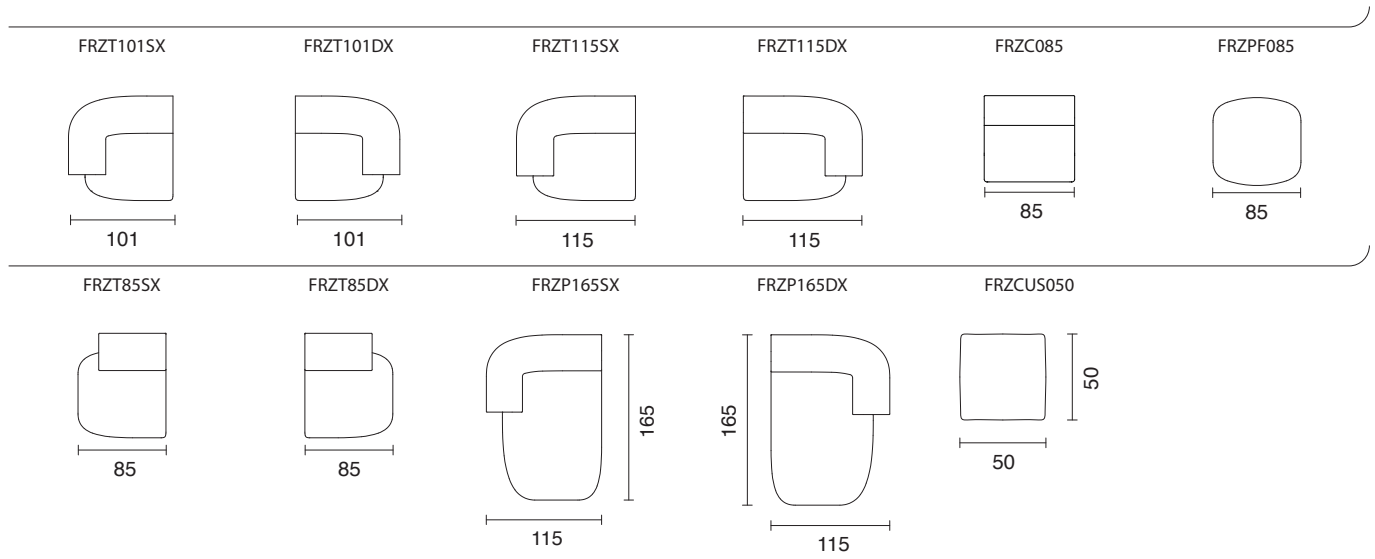

Franz

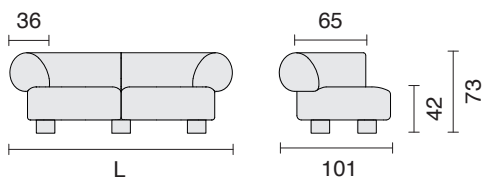

Carateristiques du produit

Sur mesure: pas disponible.

Struttura portante: multicouche et panneaux d'aggloméré.

Système de ressort: band élastiques croisées.

Rembourrage dossier: polyuréthane expansé.

Rembourrage assise: polyuréthane expansé à densité différenciée

Pieds: métal laqué H. 12 cm à vue.

Couleurs de pieds: toutes les finitions.

Modularite

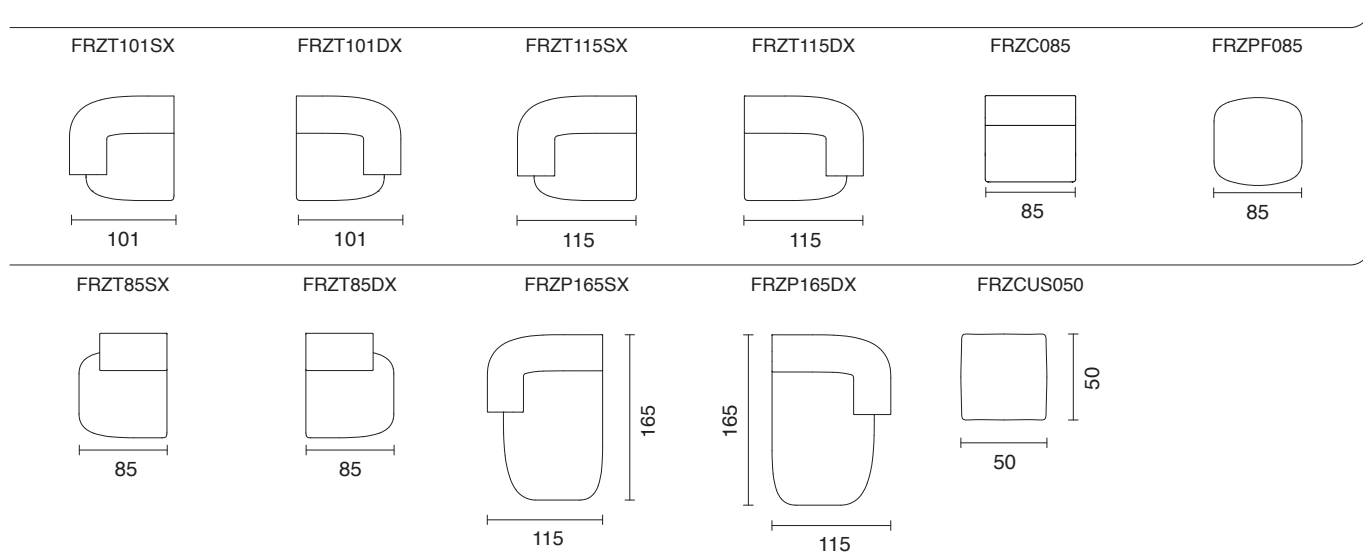

Franz

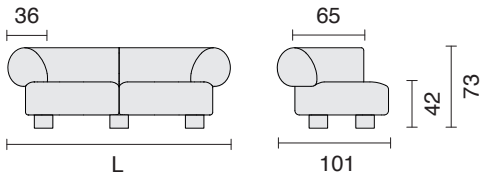

Características del producto

A medida: no disponible.

Estructura portante: multicapa y paneles de faesite.

Sistema de resorte: correas elásticas cruzadas.

Alcochado del respaldo: poliuretano expandido.

Alcochado del asiento: poliuretano expandido con densidad diferenciada.

Patas: en acero lacado H. 12 cm visible.

Patas acabados: todos los acabados.

Modularidad

FRZT101SX

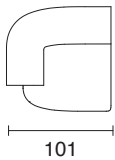

FRZT101DX

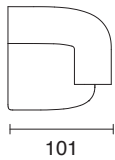

FRZT115SX

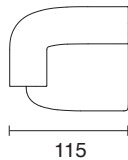

FRZT115DX

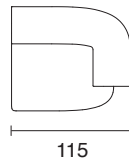

FRZC085

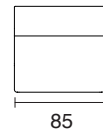

FRZPF085



FRZT85SX

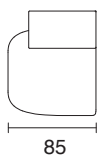

FRZT85DX



FRZP165SX

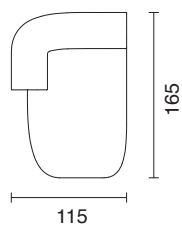

FRZP165DX

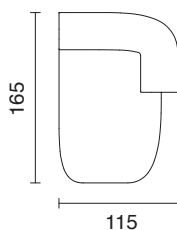

FRZCUS050

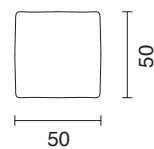

Franz

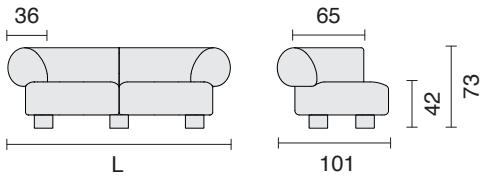

Merkmale des Produkts

Maßgeschneidert: nicht verfügbar.

Untergestell: Sperrholz und Hartfaserplatten.

Federungssystem: elastische Kreuzgurte.

Polsterung der Rückenlehne: Polyuretanschaumstoff

Polsterung des Sitzes: Polyurethanschaum unterschiedlicher Dichte.

Füße: Lackierter Stahl. H. 12 cm sichtbar.

Fußfarben: alle Ausführungen.

Module

FRZT101SX

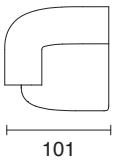

FRZT101DX

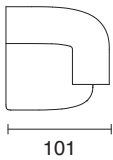

FRZT115SX

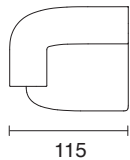

FRZT115DX

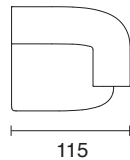

FRZC085

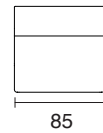

FRZPF085

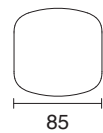

FRZT85SX

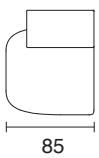

FRZT85DX



FRZP165SX

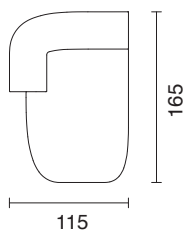

FRZP165DX

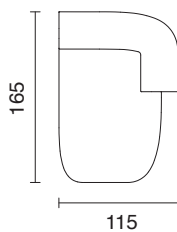

FRZCUS050

